

0 - CHECK LIST

RockyM 5+ 

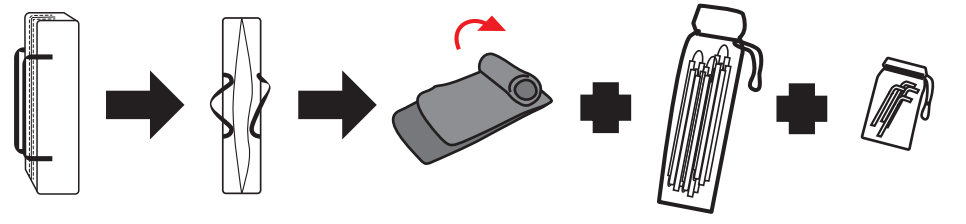

The checklist shows the components of the tent: a rolled-up tent bag, a bundle of poles, and a pack of stakes. Arrows indicate the sequence of items to be checked.

1 - SET UP

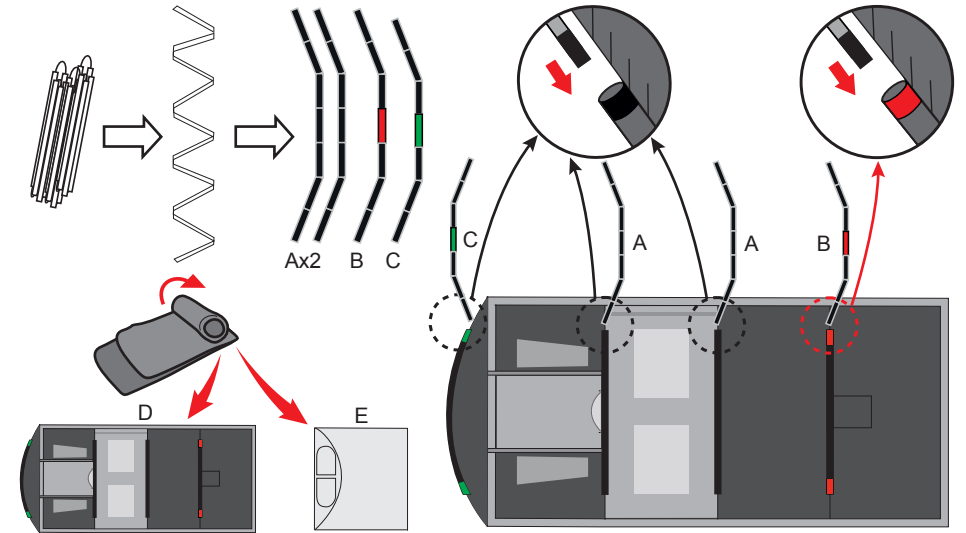

Diagram illustrating the first step of setup: attaching the poles to the tent body. The poles are labeled A, B, and C. The tent body is labeled D and E. The poles are inserted into the tent's frame. A close-up shows the pole being inserted into the tent's sleeve.

2 - SET UP

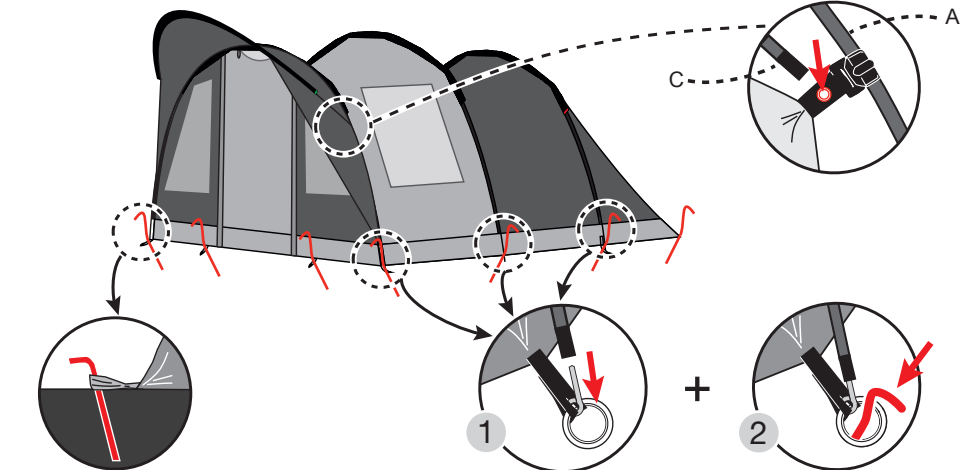

Diagram illustrating the second step of setup: attaching the tent fly to the tent body. The tent fly is shown being attached to the tent body. A close-up shows the fly being attached to the tent's frame. The diagram is labeled with 1 and 2, indicating the sequence of actions.

3 - SET UP

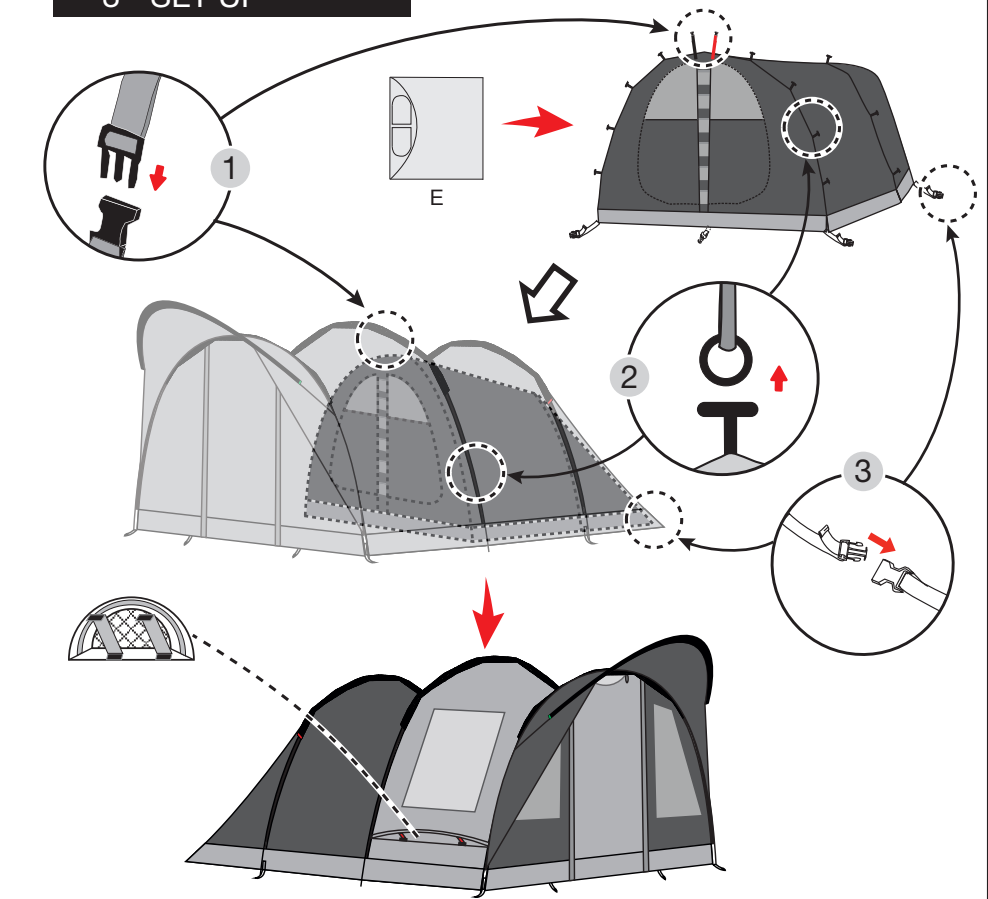

Diagram illustrating the third step of setup: securing the tent to the ground. The tent is shown being secured to the ground using stakes. A close-up shows the stake being inserted into the tent's sleeve. The diagram is labeled with 1, 2, and 3, indicating the sequence of actions.

4 - SET UP

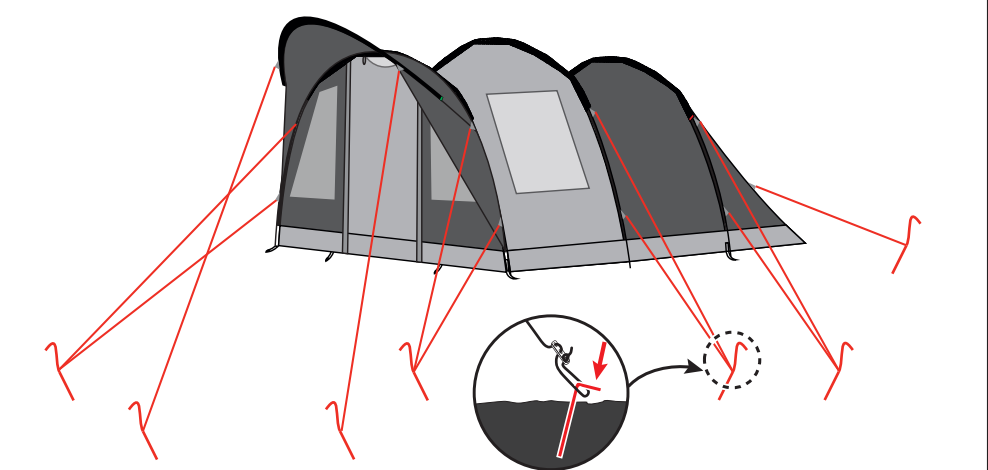
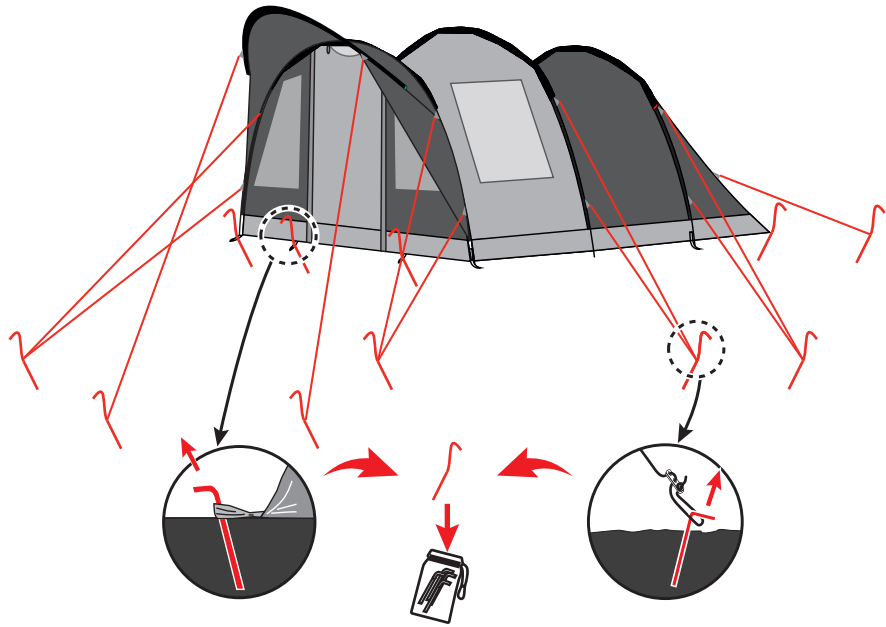
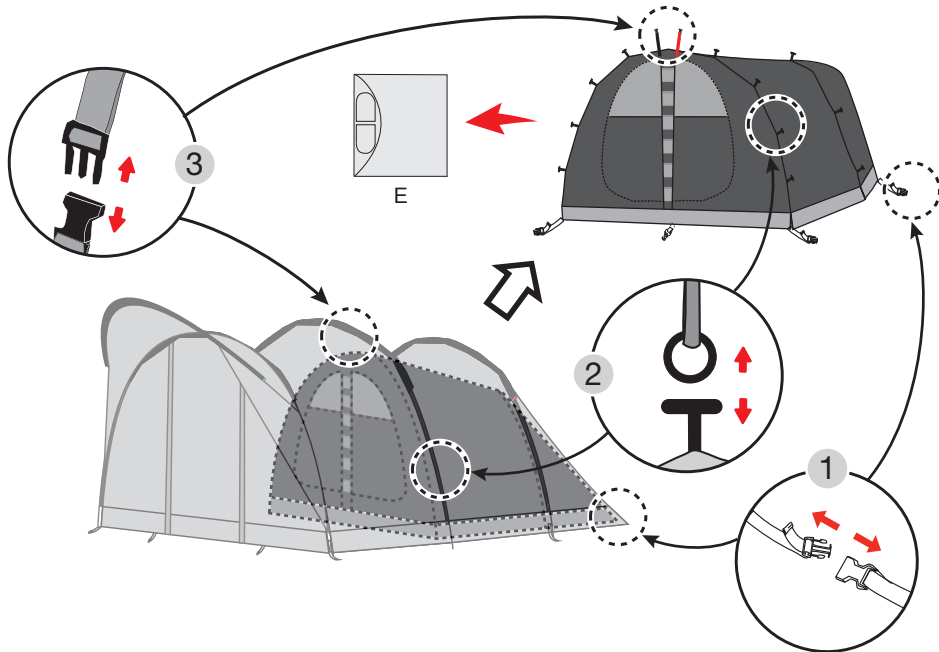

Diagram illustrating the fourth step of setup: final adjustments and securing the tent. The tent is shown being secured to the ground using stakes. A close-up shows the stake being inserted into the tent's sleeve. The diagram is labeled with 1 and 2, indicating the sequence of actions.

1 - SET DOWN



2 - SET DOWN



3 - SET DOWN

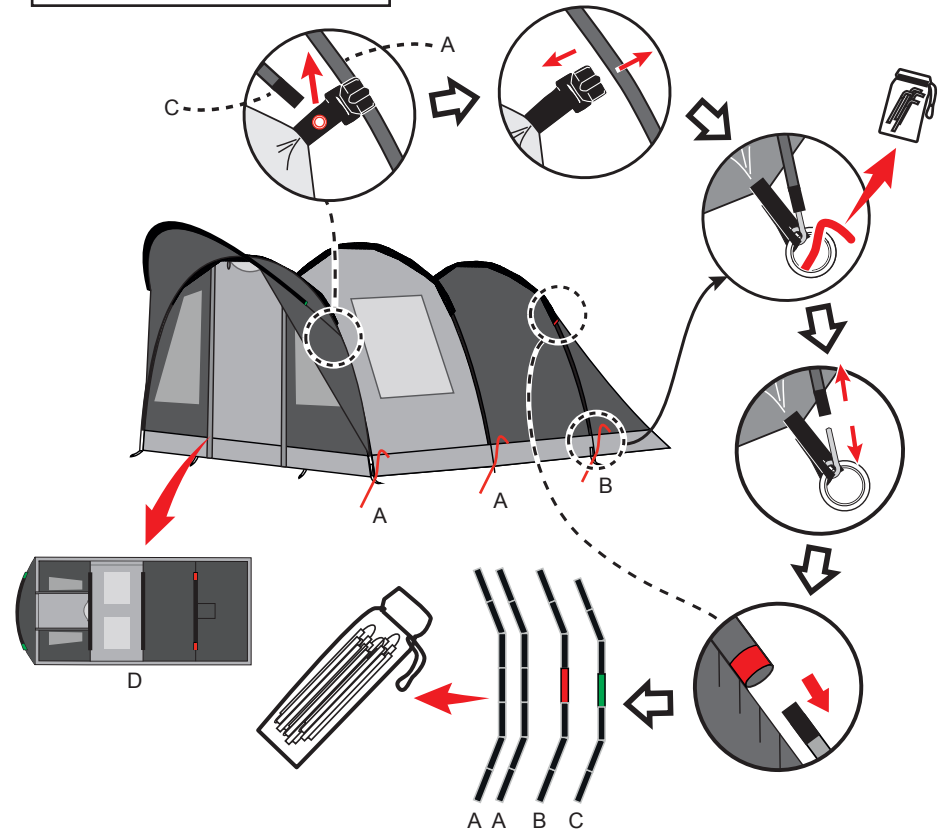

4 - SET DOWN

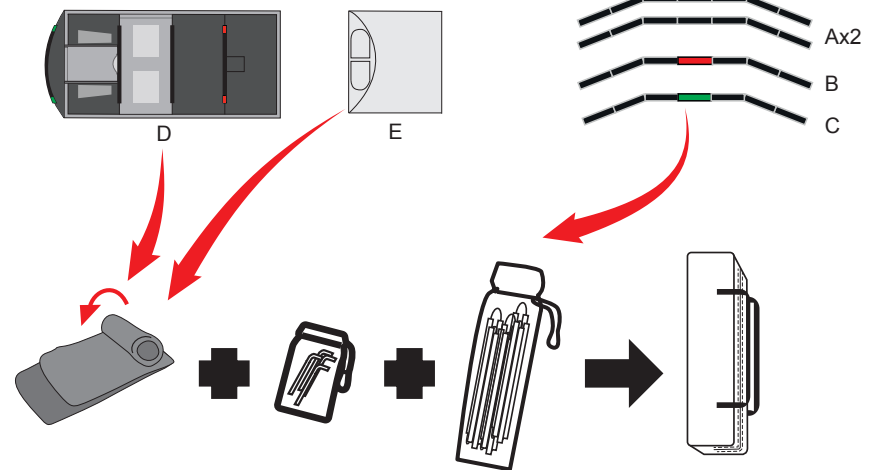

Stitch Line

Stitch Line

Warning-Attention-Achtung-Waarschuwing-Advarsler-Advarsel-Varning-Upozornění-Attenzione-Advertencia-Atenção-Varoitus-Uwaga-Upozornienie-Opozorilo-Upozorenje-Figyelmeztetés-Предупреждение-Atenție-Ispėjimas-Внимание-Ноиatus-Brīdinājums-Προειδοποίηση-Уარი - راذح

- GB** Make sure your tent is dry before packing
Store in a dry and well ventilated area
- FR** Vérifiez que votre tente est bien sèche avant de la ranger
Ranger en lieu sec et bien ventilé
- DE** Überprüfen Sie vor dem Wegräumen, dass ihr Zelt wirklich trocken ist
An einem trockenen und gut durchlüfteten Ort aufbewahren
- NL** Zorg ervoor dat uw tent droog is voordat u ze inpakt
Bewaar de tent op een droge en goed verluchte plaats
- IT** Verificate che la tenda sia perfettamente asciutta prima di riporla
Riporre in luogo asciutto e ben ventilato
- ES** Compruebe que la tienda de campaña esté seca antes de guardarla.
Guárdela en un lugar seco y bien ventilado
- PT** Certifique-se que a tenda está seca antes de a embalar.
Guardar em local seco e bem ventilado
- CZ** Před zabaléním se ujistěte, že je vš stan suchý.
Skladujte na suchém a dobře větraném místě.
- FI** Varmista, että teltta on kuivunut ennen kuin pakkaat sen
Säilytä kuivassa ja hyvin tuuletetussa paikassa
- DK** Sørg for, at dit telt er tørt, før du pakker det.
Opbevar på et tørt og godt ventileret sted
- SE** Se till att Ditt tält är torrt innan det packas
Förvara i torrt och väl ventilerat utrymme
- NO** Sørg for at teltet ditt er tørt før du pakker det sammen
Lagres på et tørt og godt ventilert sted.
- PL** Przed złożeniem należy sprawdzić, czy namiot jest suchy
Przechowywać w suchym i dobrze wietrzonym miejscu
- SI** Šotor mora biti pred pakiranjem suh
Hranite v suhem in dobro prezračnem prostoru
- SK** Pred zbalením skontrolujte, či je stan vyschnutý
Skladujte na suchom a dobre vetranom mieste
- HU** Becsomagolás előtt győződjön meg arról, hogy a sátor megszáradt
Száras, jól szellőző helyen tárolandó
- HR** Uvjerite se da je vaš šator osušen prije pakiranja
Pohraniti na suhom i dobro prozračenom području
- RU** Перед тем как упаковывать тент, убедитесь в том, что он высох.
Храните в сухом и хорошо проветриваемом месте
- BG** Преди опаковане се уверете, че палатката е суха
Съхранявайте на сухо и добре проветрено място
- RO** Înainte de împachetare, asigurați-vă că cortul este uscat.
Depozitați într-un loc uscat și bine ventilat
- EE** Kontrollige, et telk oleks enne pakkimist kuiv.
Hoida kuivas ja hästi õhutatud kohas
- LV** Pārlicinieties, ka pirms salikšanas jūsu telts ir sausa
Uzglabāt sausā, labi vēdināmā vietā
- LT** Prieš supakuodami įsitikinkite, ar jūsų palapinė išdžiuvusi
Saugoti sausoje ir gerai vėdinamoje vietoje
- GR** Βεβαιωθείτε ότι η σκηνή σας είναι στεγνή πριν την πακετάρετε.
Αποθηκεύστε τη σκηνή σε στεγνή περιοχή με καλό εξαερισμό.
- TR** Çadırınızı paketlemeden önce kuru olduğundan emin olun
Kuru ve iyi havalandırılan yerde saklayın
- AR** تأكد من جفاف خيمتك قبل حزمها.
يتم التخزين في مكان جاف ومتهوية جيداً.